

Videx 3121 Sentry Systems

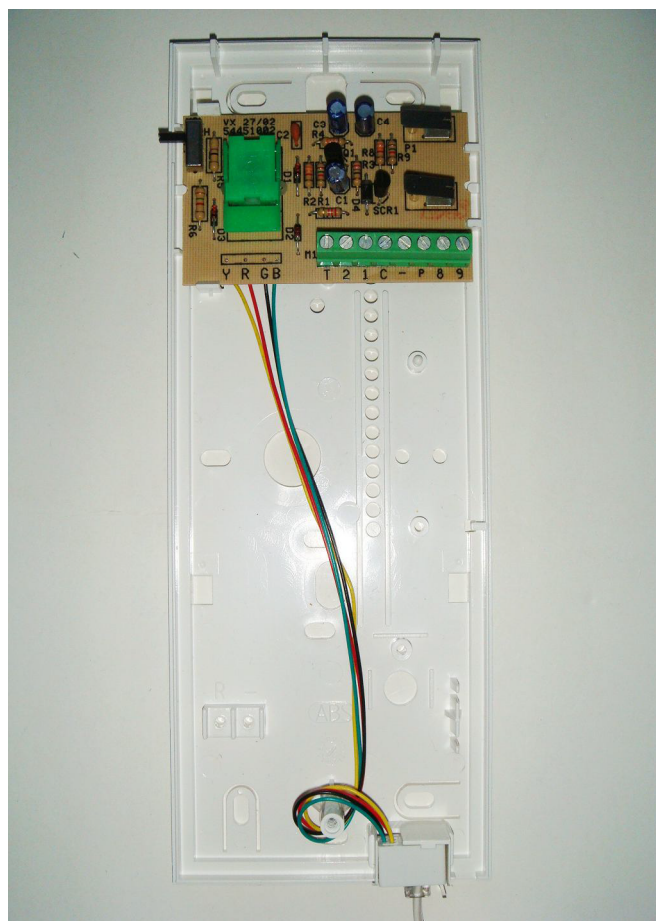

Terminals

T	Call Tone
2	Speech In (Speaker)
1	Speech Out (Mic)
C	Select Line (Handset On)
-	Common
P	Switch 0V Lock Trigger
8/9	Volt Free N/O Button

IMPORTANT NOTE :

1) Before replacing the handset make note of the wires to each terminal on the existing unit (an easy way is to cut each core off leaving a piece of the insulation in place with colour visible) twist unused cores together (so you know they are not used, do not short them out).

2) Some older systems will have cable with one coloured core and a solid white core in this case mark each core with a marker or tape.

3) Some systems may have loop on wiring, you will have 2 cables into your handset (make sure any joins remain, as these may be serving other flats on the system).

Wiring Diagram

(See Sentry Manual for more info)

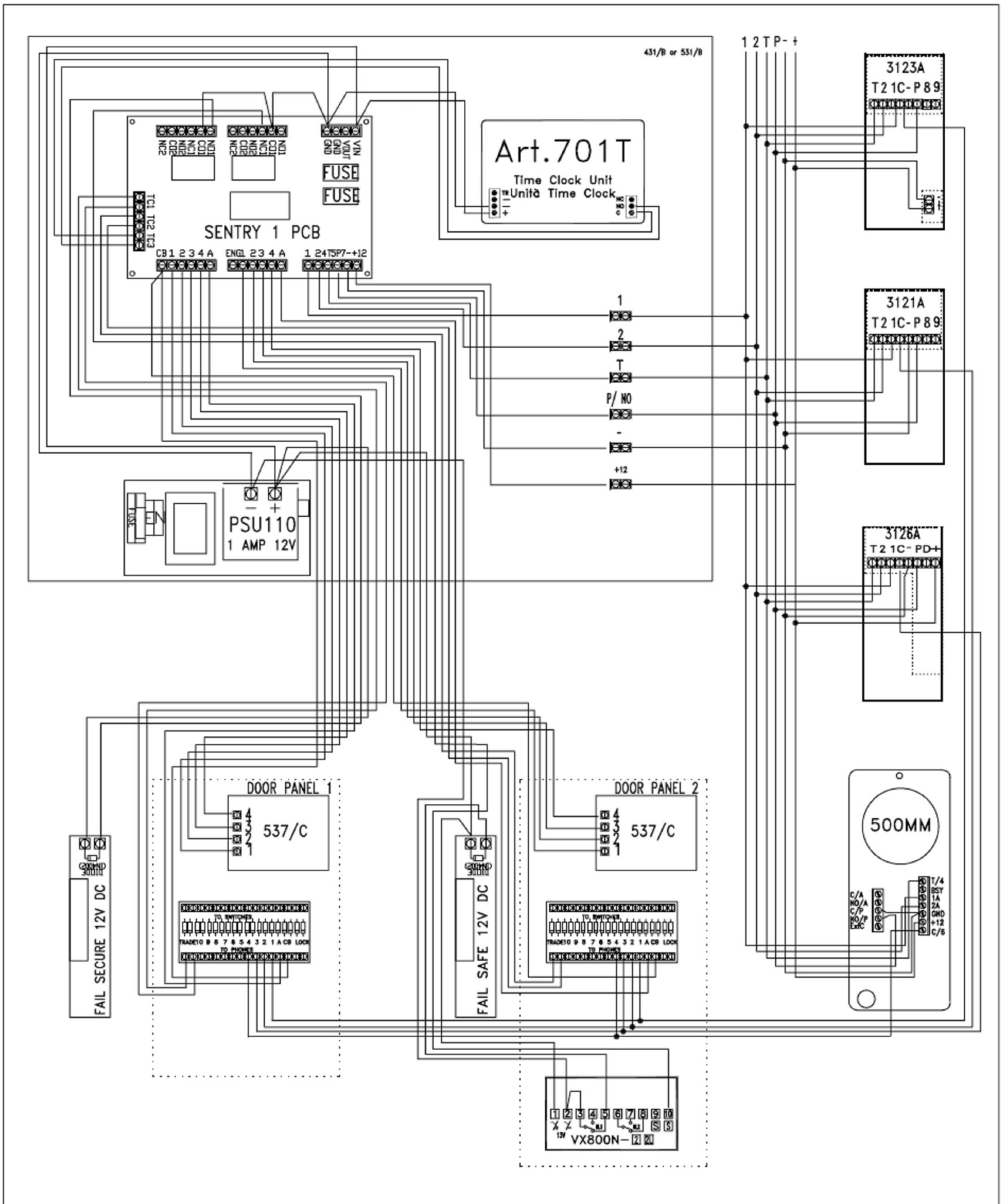

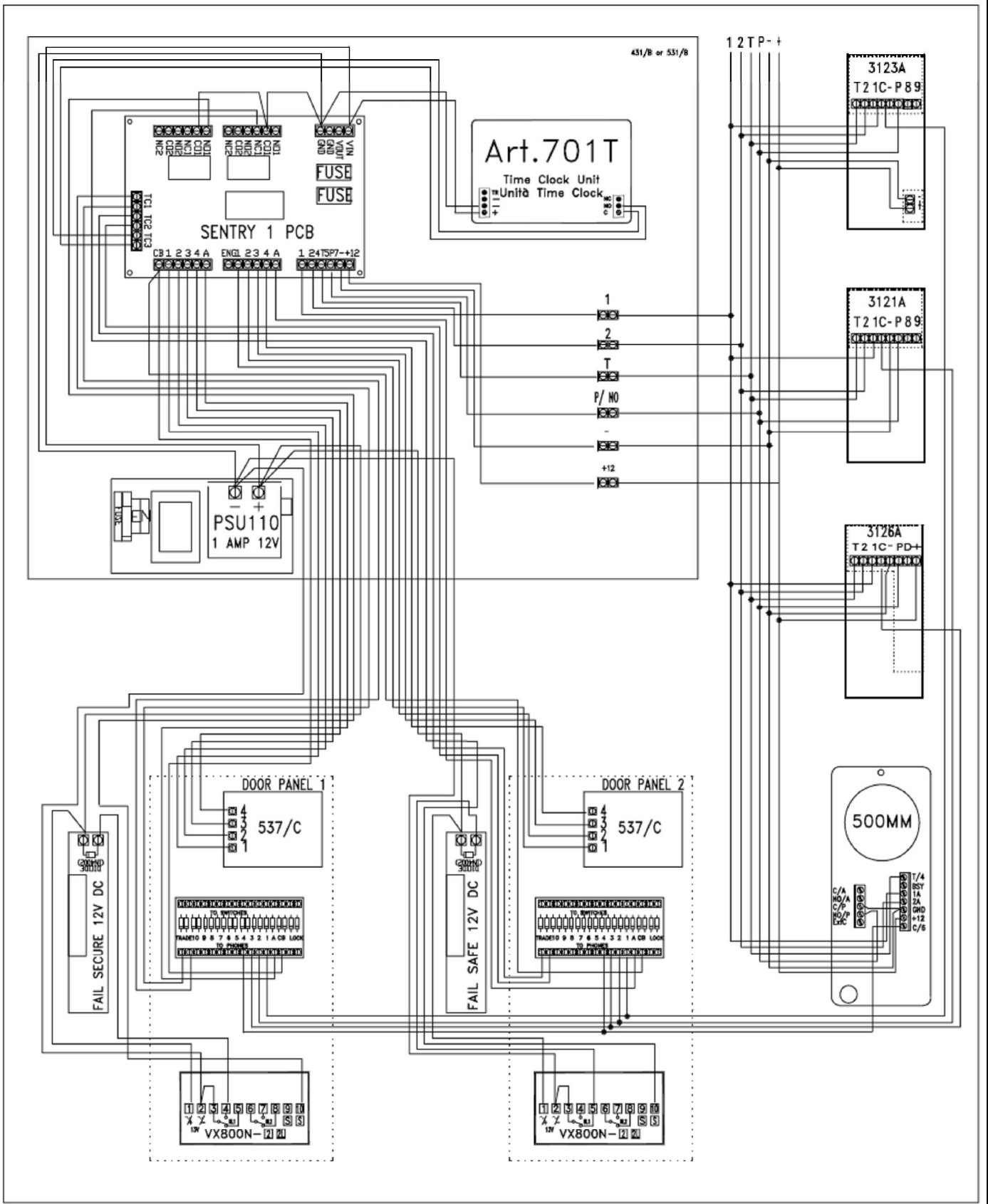

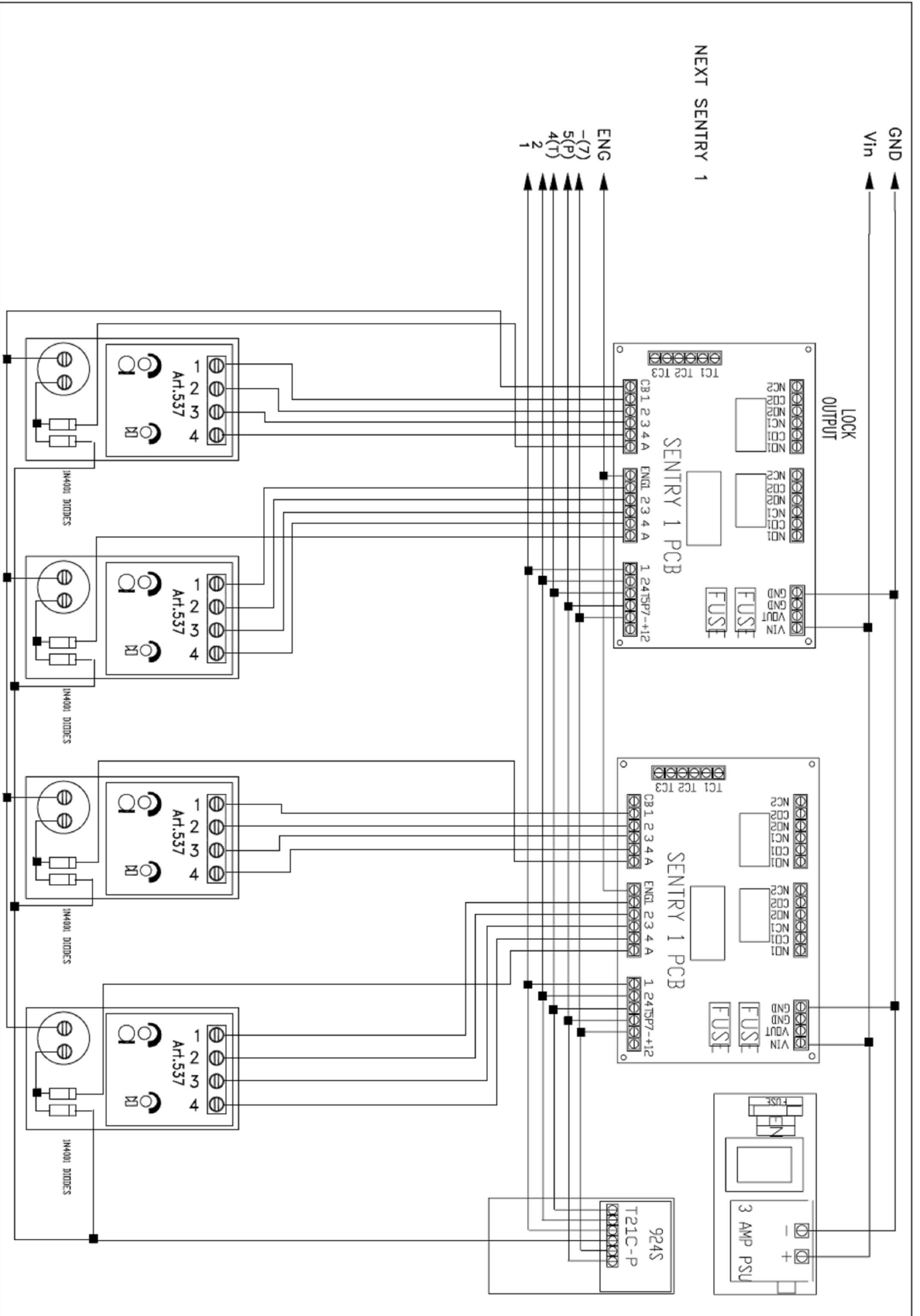

GND

Vin

LOCK
OUTPUT

NEXT SENTRY 1

ENG
-(7)
5(P)
4(T)
2
1

SENTRY 1 PCB

SENTRY 1 PCB

924S
T21C-P

3 AMP PSU

1M4001 DIODES

1M4001 DIODES

1M4001 DIODES

1M4001 DIODES

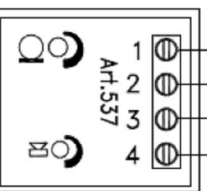
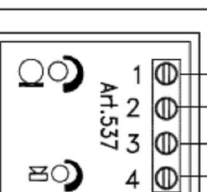
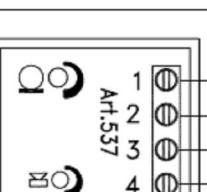
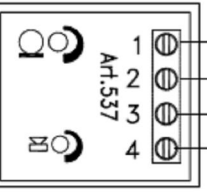

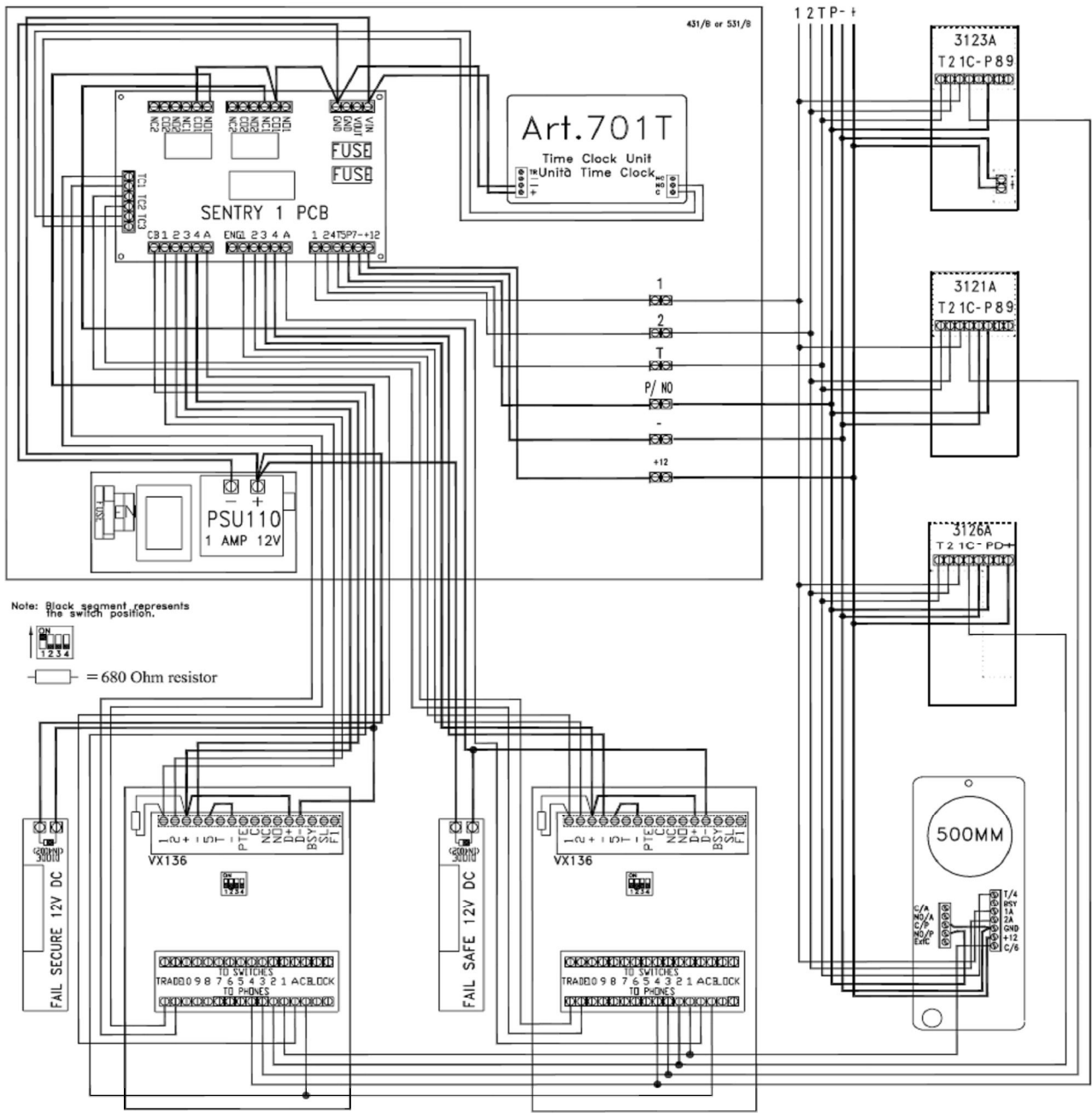

TELEPHONE CONNECTIONS COMPATIBILITY CHART

AUDIO TELEPHONES

MODEL	Transmit Speech	Receive Speech	Call Tone	Lock Release	Ground	Trigger	+12V	Door Monitor
3121	1	2	T	P	-	C	N/A	N/A
3123	1	2	T	P	-	C	+	N/A
3125	1	2	T	P	-	C	+12	D
3126	1	2	T	P	-	C	+12	D
924S	1	2	T	P	-	C	N/A	N/A
924MSL	1	2	T	P	-	C	+	N/A
940MS2L	1	2	T	P	-	C	+12	D
940ST	1	2	T	P	-	C	+12	D
524S	1	2	4H or 4L	5	7	6	N/A	N/A
524MS	1	2	4H or 4L	5	7M	6	N/A	N/A
524MSL	1	2	4H or 4L	5	7M	6	+	N/A
526ST	1	2	T	P	-	C	+	D
500MM	1A	2A	T/4	NO/P	GND	C/6	+12	N/A

APARTMENT STATIONS

MODEL	SELECT	SWITCHED 12V	TALK BUTTON	LOCK BUTTON	AUDIO	GND	+12V SUPPLY	DOOR MONITOR
500	4	2	6	1	3	5	N/A	N/A
500M	4	2	6	1	3	5	+	D
500ST	4	2	6	1	3	5	+	D

TROUBLE SHOOTING GUIDE

When trouble shooting a large system, it will be easier to break the system down to a manageable size. The simplest way to do this is to remove all but one handset. Doing this, you can confirm the door panel and control cabinet are free from faults. Once this has been confirmed you can reconnect the handsets in small sets, testing after each set to see if the fault has re-appeared.

No speech from door panel : Check terminal 2 on the amplifier for continuity back to the sentry 1 PCB. Check terminal 2 on the handset for continuity back to the sentry 1 PCB. During a call but before the handset is lifted, terminal 2 should have a voltage of approximately 12Vdc. Once th handset is lifted, this voltage should drop to approximately 1Vdc. During standby with no call on the system, terminal 2 should not have a voltage present.

No speech from handset : Check terminal 1 on the amplifier for continuity back to the sentry 1 PCB. Check terminal 1 on the handset for continuity back to the sentry 1 PCB. During a call but before the handset is lifted, terminal 1 should have a voltage of approximately 12Vdc. Once th handset is lifted, this voltage should drop to approximately 4Vdc. During standby with no call on the system, terminal 1 should not have a voltage present.

Handset bleeps only once : Check the voltage across terminals 3 & 4 on the door amplifier. This voltage will be 12V DC when a call is activated. This voltage should stay the same throughout the call and return to zero volts once the call ends.

Handset rings for only 1 second : Check terminal 1 of the amp for continuity back to the sentry 1 PCB. Check terminal 1 of the handset for continuity back to the sentry 1 PCB.

Phone does not stop ringing when handset is lifted : Check terminal 2 on handset for continuity back to the sentry 1 PCB.

Lock will not operate : Check the relay is activating on the sentry 1 PCB (If it is not, check terminal 5 on the handset for continuity back to the sentry PCB). Check the voltage across the release when the relay is activated). Terminal 5(P) on the handsets should have 5Vdc on at all times except when the lock release button is pressed (during a call to that handset).

Lock operates as soon as the handset is lifted : There is a short between terminals 5(P) and 2 on the handset cables or 5(P) is shorted to ground (Check for 5Vdc on 5(P), this voltage originates at the Sentry 1 PCB).

When any button is pressed nothing happens : Check the CB connection on the sentry 1 PCB (The voltage on this terminal should be +12V DC). Also check this at the door panel. The CB voltage should be there when the system is in standby but may not be there during a call depending on the position of JPR1.

No call tone to the handset (speech and lock ok) : Check terminal 4(T) on the handset for continuity back to the sentry 1 PCB. Check Fuse 2 on the Sentry 1 PCB

Hum on the speech lines : Check the intercom cables are not running close to any high voltage or mains cables.