

ENSIGN 3407

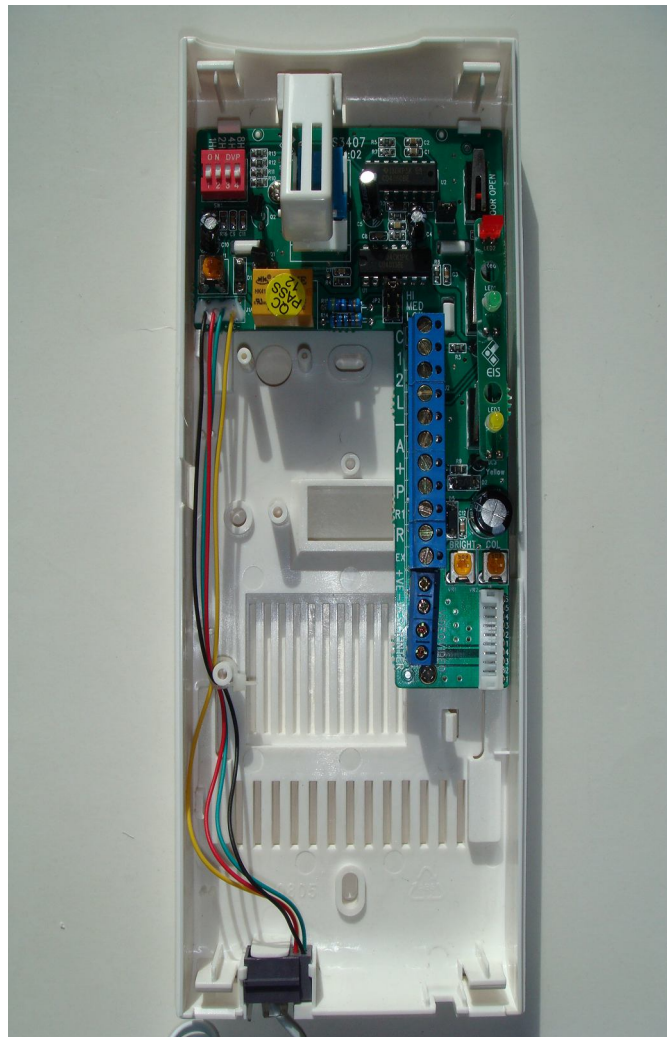

Terminals

C	+
1	P
2	R
L	
-	
A	

IMPORTANT NOTE :

1) Before replacing the handset make note of the wires to each terminal on the existing unit (an easy way is to cut each core off leaving a piece of the insulation in place with colour visible) twist unused cores together (so you know they are not used, do not short them out).

2) Some older systems will have cable with one coloured core and a solid white core in this case mark each core with a marker or tape.

3) Some systems may have loop on wiring, you will have 2 cables into your handset (make sure any joins remain, as these may be serving other flats on the system).

EIS 3407 Handset Connections

Green/White	C
Blue/White	1
White/Blue	2
White/Orange	L
Orange/White	-
White/Green	A
Brown White	+

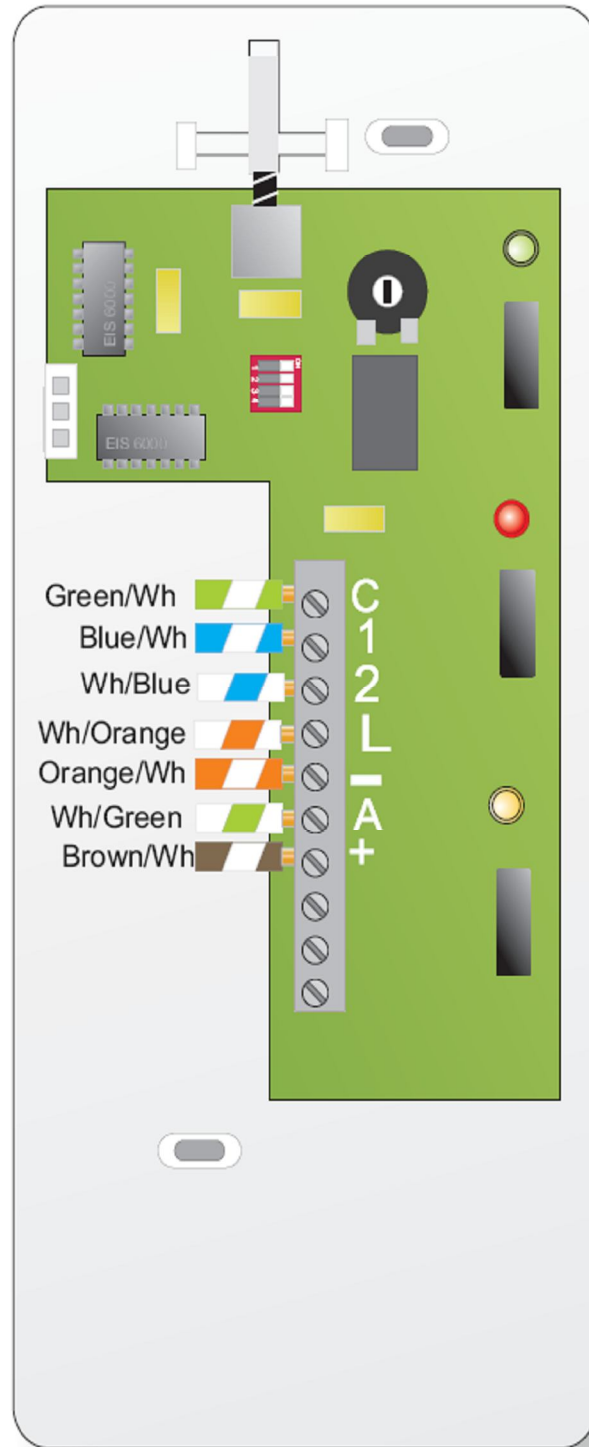

P and R not
used on Audio
Systems

Switch setting chart

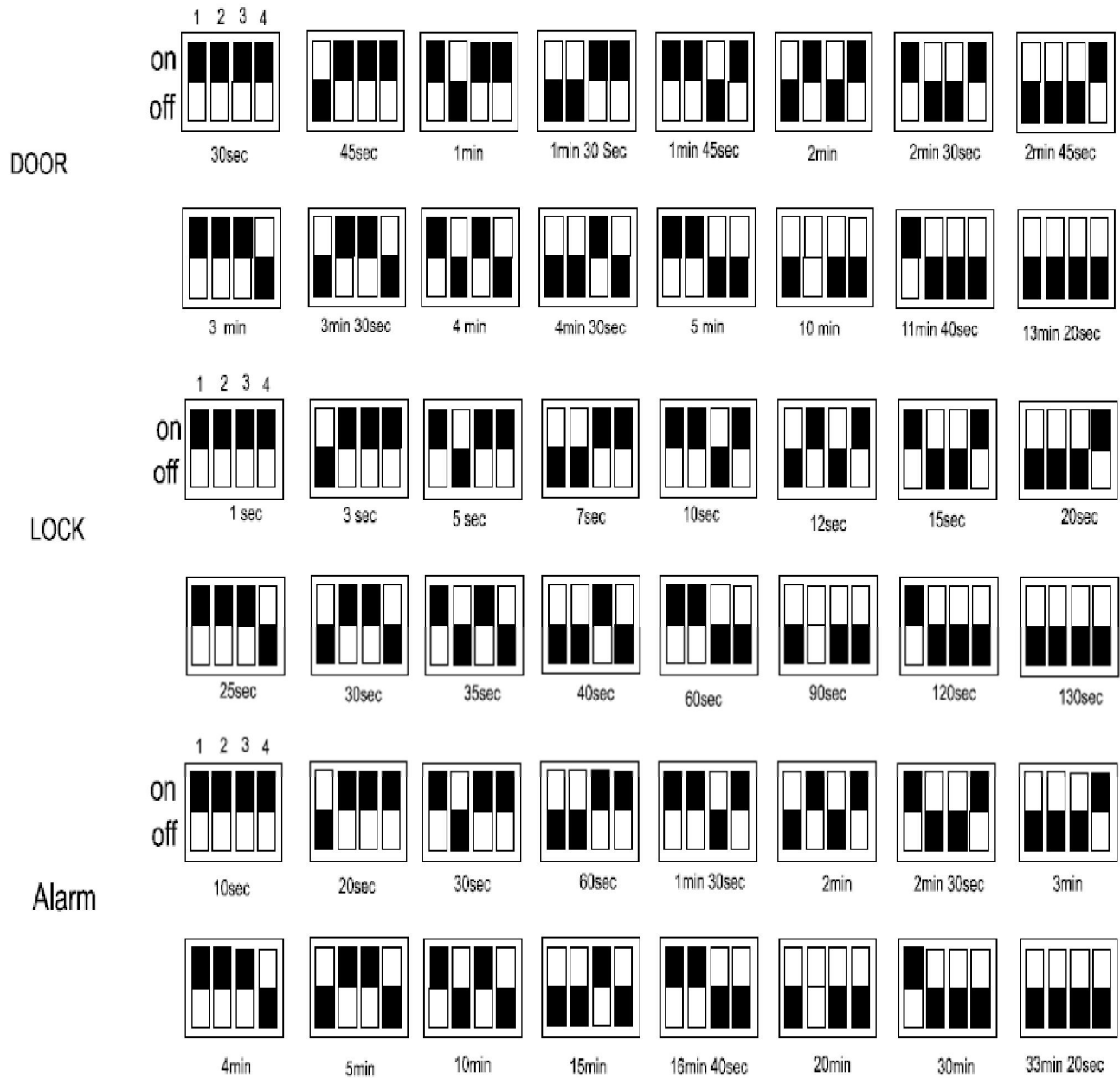

Switches shown in white.

3400 System wiring

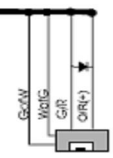
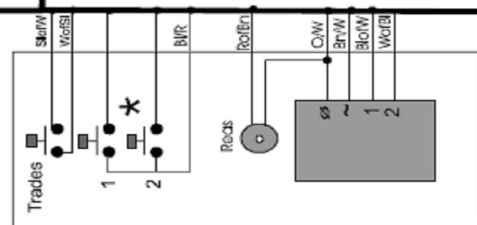
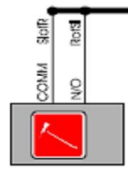
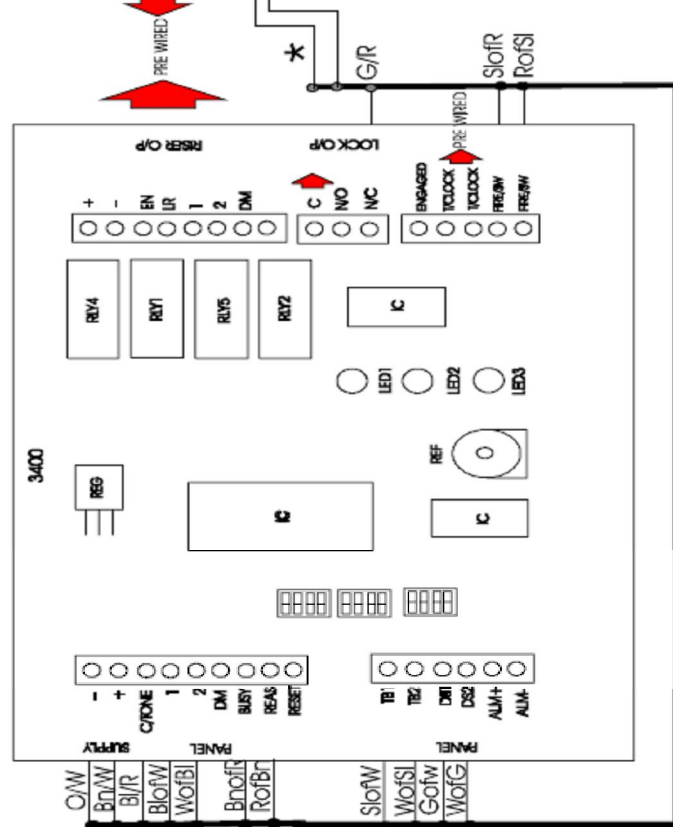
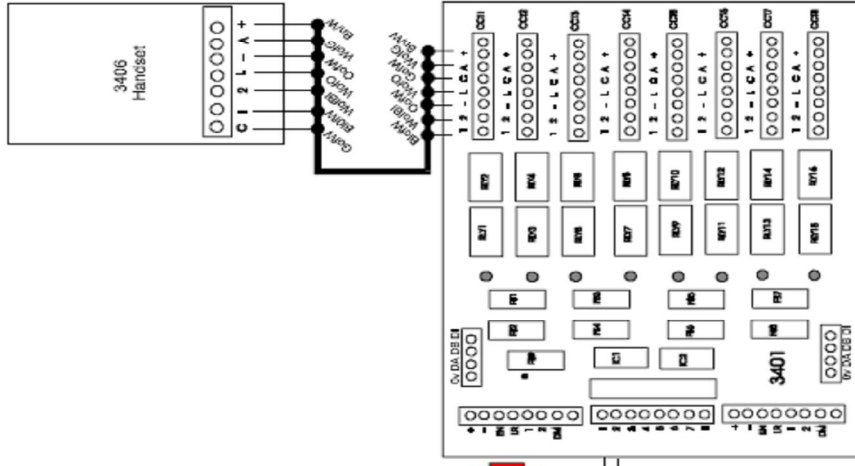

Note: connect O/R (lock +) to supply + on 3400 PCB

TITLE	3400 WIRING	Date	20/05/98
CLIENT			
CONTACT		REF	34MAN
		